

PLAN

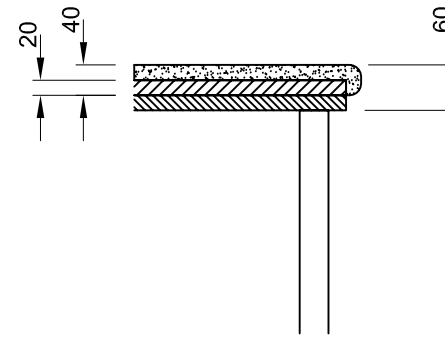

GRANITE TOP DETAIL

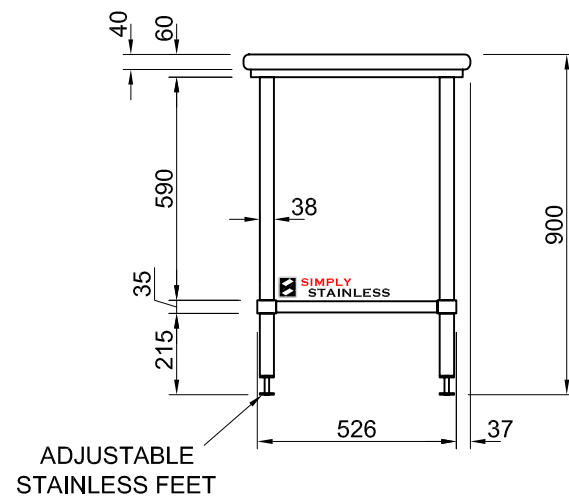

FRONT ELEVATION

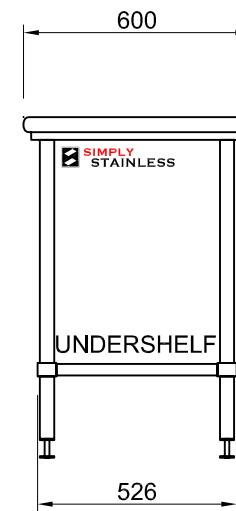

SIDE ELEVATION

23-0600

TOPS COME IN EITHER BLACK PEARL OR DOLLAMITE WHITE



www.simplystainless.com  
Modular Sinks Tables and Shelving

CI GROUP PTY LTD COPYRIGHT ©

This drawing is the property of CI GROUP PTY LTD trading as Simply Stainless, and it may not be copied, reproduced or modified in whole or in part, without prior written permission of CI GROUP PTY LTD.

**23-0600 GRANITE BENCH**

SCALE 1:20

**CONSTRUCTION NOTES:**

1. TOPS MADE FROM 20mm GRANITE STONE.
2. CORE MADE FROM 3.0mm ZINC ANNEAL.
3. FRAME MADE FROM Ø38mm STAINLESS STEEL TUBE.
4. UNDERSHELF MADE FROM 1.2mm STAINLESS STEEL.
5. FEET ARE ADJUSTABLE STAINLESS STEEL DISC SHAPED FEET.