

INLET BENCH PROFILE

SCALE 1 : 10

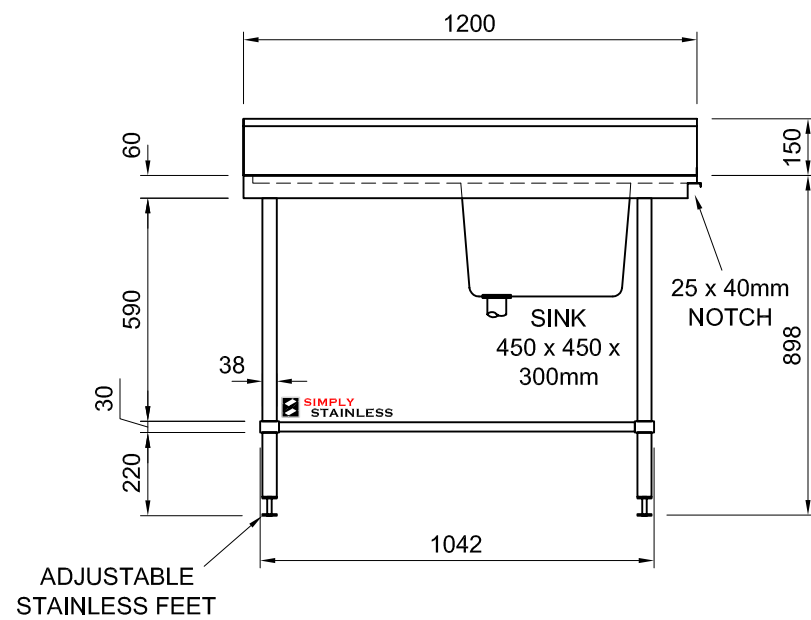

FRONT ELEVATION

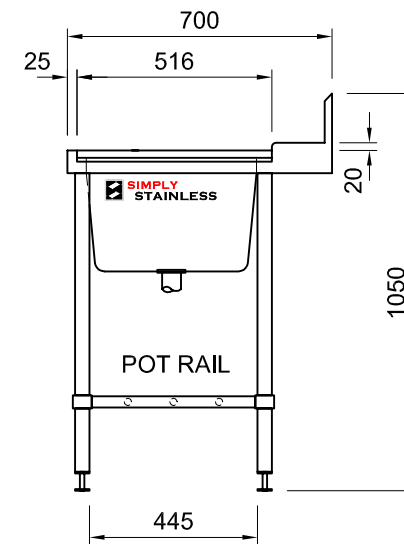

SIDE ELEVATION

08-7-1200L

SIMPLY STAINLESS
www.simplystainless.com
Modular Sinks Tables and Shelving

CI GROUP PTY LTD COPYRIGHT ©

This drawing is the property of CI GROUP PTY LTD trading as SIMPLY STAINLESS, and it may not be copied, reproduced or modified in whole or in part, without prior written permission of CI GROUP PTY LTD.

08-7-1200L INLET BENCH

SCALE 1:20

CONSTRUCTION NOTES:

1. TOPS MADE FROM 1.2mm STAINLESS STEEL.
2. CORE MADE FROM 3.0mm ZINC ANNEAL.
3. SINKS MADE FROM 1.2mm STAINLESS STEEL.
4. FRAME MADE FROM Ø38mm STAINLESS STEEL TUBE.
5. POT RAIL MADE FROM STAINLESS STEEL ROUND TUBE.
6. FEET ARE ADJUSTABLE STAINLESS STEEL DISC SHAPED FEET.