

PLAN

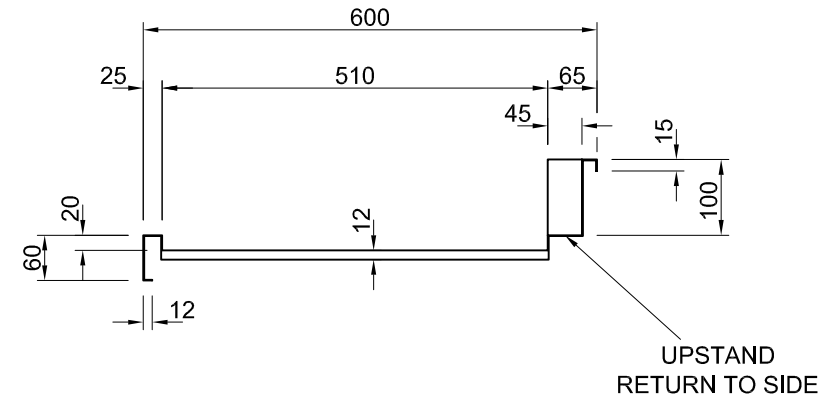

OUTLET BENCH PROFILE

SCALE 1 : 10

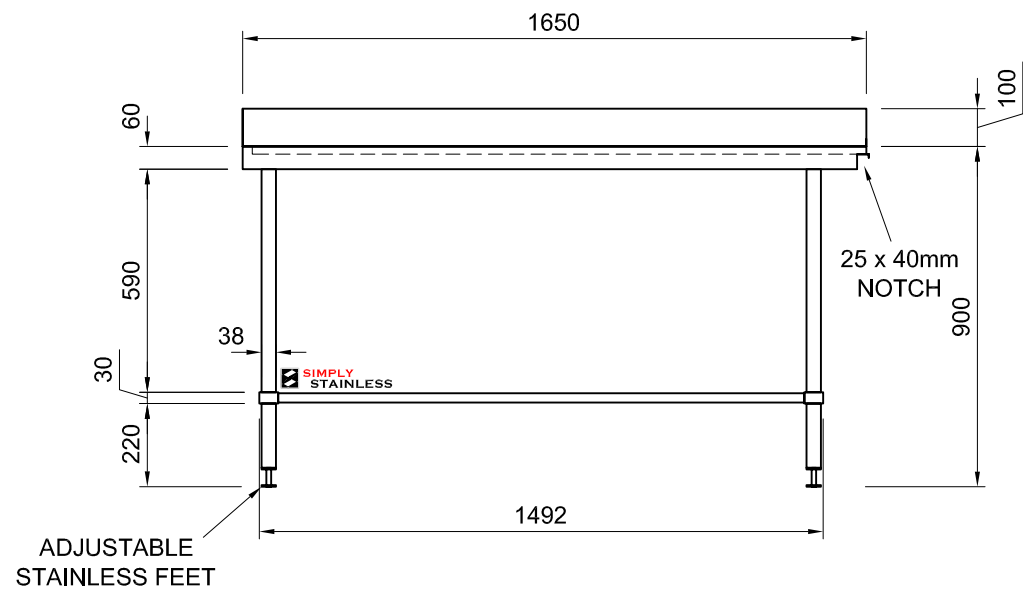

FRONT ELEVATION

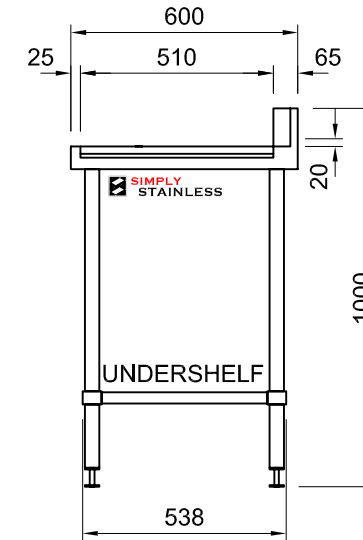

SIDE ELEVATION

07-6-1650L



www.simplystainless.com
Modular Sinks Tables and Shelving

CI GROUP PTY LTD COPYRIGHT ©

This drawing is the property of CI GROUP PTY LTD trading as SIMPLY STAINLESS, and it may not be copied, reproduced or modified in whole or in part, without prior written permission of CI GROUP PTY LTD.

07-6-1650L OUTLET BENCH

SCALE 1:20

CONSTRUCTION NOTES:

1. TOPS MADE FROM 1.2mm STAINLESS STEEL.
2. CORE MADE FROM 3.0mm ZINC ANNEAL.
3. FRAME MADE FROM Ø38mm STAINLESS STEEL TUBE.
4. UNDERSHELF MADE FROM 1.2mm STAINLESS STEEL WITH STAINLESS STEEL SUPPORTS.
5. FEET ARE ADJUSTABLE STAINLESS STEEL DISC SHAPED FEET.