

PLAN

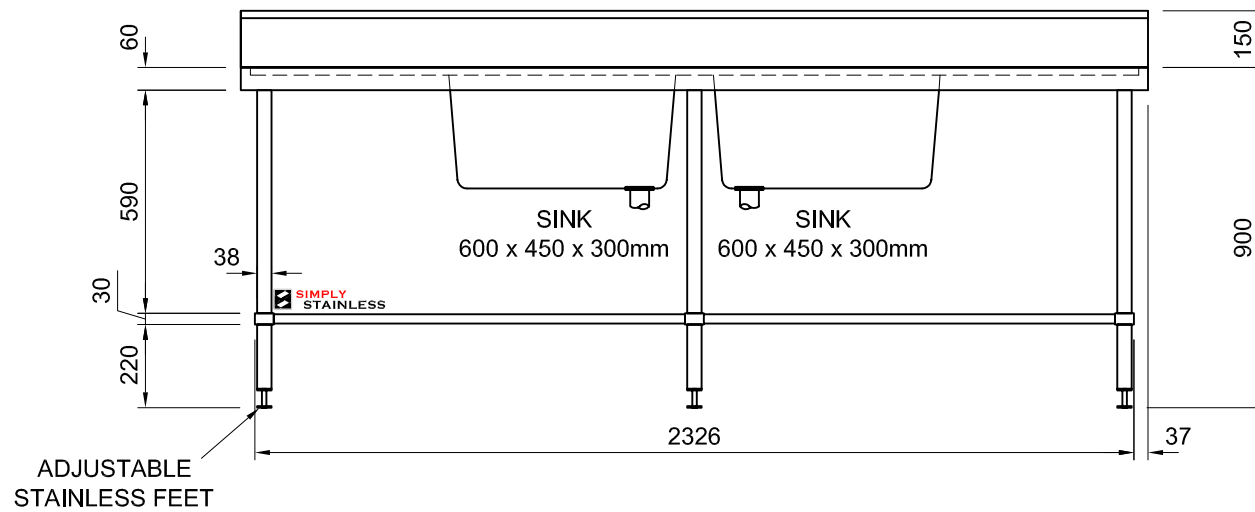

FRONT ELEVATION

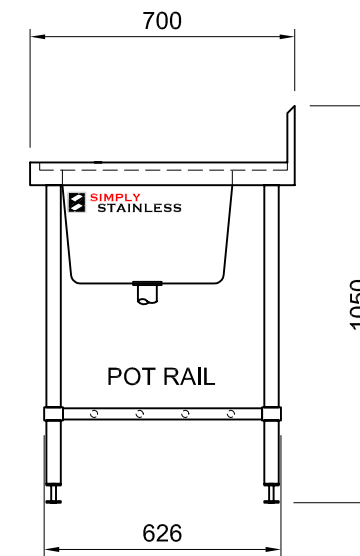

SIDE ELEVATION

06-7-2400

SIMPLY STAINLESS
 www.simplystainless.com
 Modular Sinks Tables and Shelving

CI GROUP PTY LTD COPYRIGHT ©

This drawing is the property of CI GROUP PTY LTD trading as SIMPLY STAINLESS, and it may not be copied, reproduced or modified in whole or in part, without prior written permission of CI GROUP PTY LTD.

06-7-2400 DOUBLE SINK BENCH

SCALE 1:20

CONSTRUCTION NOTES:

1. TOPS MADE FROM 1.2mm STAINLESS STEEL.
2. CORE MADE FROM 3.0mm ZINC ANNEAL.
3. SINKS MADE FROM 1.2mm STAINLESS STEEL.
4. FRAME MADE FROM Ø38mm STAINLESS STEEL TUBE.
5. POT RAIL MADE FROM STAINLESS STEEL ROUND TUBE.
6. FEET ARE ADJUSTABLE STAINLESS STEEL DISC SHAPED FEET.